

High Precision TCXO / VCTCXO



2111 Comprehensive Drive
Aurora, Illinois 60505
Phone: 630-851-4722
Fax: 630-851-5040

www.conwin.com

US Headquarters:
630-851-4722
European Headquarters:
+353-61-472221

Description

The Connor-Winfield 5.0x7.0mm Temperature Compensated Crystal Controlled Oscillators and Voltage Controlled Temperature Compensated Crystal Controlled Oscillators are designed for use in applications requiring tight frequency stability in a small package. Through the use of Analog Temperature Compensation, this device is capable of holding sub 1-ppm stabilities over the commercial or the industrial temperature ranges.

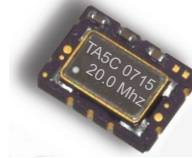

Features:

- 3.3V or 5.0V Operation
- CMOS or Clipped Sinewave Output Logic
- Miniature 5x7mm Surface Mount Package
- Frequency Stabilities Available:
 - Tx5C / Tx6C Series: ± 0.25 ppm
 - Tx5E / Tx6E Series: ± 0.50 ppm
 - Tx5F / Tx6F Series: ± 1.00 ppm
- Temperature Ranges Available:
 - Tx5x Series: 0 to 70°C
 - Tx6x Series: -40 to 85°C
- Low Jitter < 1pS RMS
- Tri-State Enable/Disable Function
- Tape and Reel Packaging
- RoHS Compliant / Lead Free **RoHS**
- Recommended for new designs

Applications

GPS Receivers
Instrumentation
Femtocells
FTTH, FTTC

Ordering Information

TA5C - 020.0M

TCXO SERIES Example Part Number CENTER FREQUENCY

Package Layout

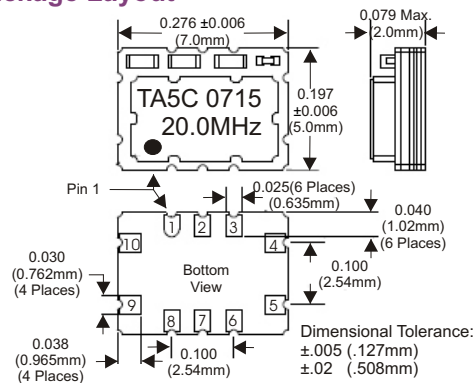

Pin Connections

1	Do not connect
2	Do not connect
3	Do not connect
4	Ground
5	Output
6	Do not connect
7	Do not connect
8	Tri-state Enable / Disable
9	Supply, Vcc
10	Voltage Control (VCTCXO) N/C (TCXO)

Standard Frequencies Available *

6.4 MHz 9.72 MHz 10.0 MHz 10.24 MHz 12.5 MHz 12.8 MHz
13.5 MHz 19.44 MHz 20.0 MHz 20.48 MHz 25 MHz 27 MHz 38.88 MHz

* Available frequencies from the factory for small quantity orders or quick delivery. Additional frequencies are available.



Bulletin	Tx180
Page	1 of 4
Revision	04
Date	10 Aug 2007

Model Specifications

±0.25ppm Model Specifications

Model Number	TA5C	TB5C	TE5C	TF5C	TC5C	TD5C	TG5C	TH5C
Output Type	LVC MOS	Clipped Sinewave	LVC MOS	Clipped Sinewave	HCMOS	Clipped Sinewave	HCMOS	Clipped Sinewave
TCXO / VCTCXO	TCXO	TCXO	VCTCXO	VCTCXO	TCXO	TCXO	VCTCXO	VCTCXO
Supply Voltage	3.3Vdc	3.3Vdc	3.3Vdc	3.3Vdc	5.0Vdc	5.0Vdc	5.0Vdc	5.0Vdc
Frequency Range	6 to 40 MHz	6.4 to 52 MHz	6 to 40 MHz	6.4 to 52 MHz	6 to 40 MHz	6.4 to 52 MHz	6 to 40 MHz	6.4 to 52 MHz
Frequency Stability	±0.25ppm (Note 1)							
Temperature Range	0 to 70°C							

Table 1.0

Model Number	TA6C	TB6C	TE6C	TF6C	TC6C	TD6C	TG6C	TH6C
Output Type	LVC MOS	Clipped Sinewave	LVC MOS	Clipped Sinewave	HCMOS	Clipped Sinewave	HCMOS	Clipped Sinewave
TCXO / VCTCXO	TCXO	TCXO	VCTCXO	VCTCXO	TCXO	TCXO	VCTCXO	VCTCXO
Supply Voltage	3.3Vdc	3.3Vdc	3.3Vdc	3.3Vdc	5.0Vdc	5.0Vdc	5.0Vdc	5.0Vdc
Frequency Range	6 to 40 MHz	6.4 to 52 MHz	6 to 40 MHz	6.4 to 52 MHz	6 to 40 MHz	6.4 to 52 MHz	6 to 40 MHz	6.4 to 52 MHz
Frequency Stability	±0.25ppm (Note 1)							
Temperature Range	-40 to 85°C							

Table 2.0

±0.50ppm Model Specifications

Model Number	TA5E	TB5E	TE5E	TF5E	TC5E	TG5E	TG5E	TH5E
Output Type	LVC MOS	Clipped Sinewave	LVC MOS	Clipped Sinewave	HCMOS	Clipped Sinewave	HCMOS	Clipped Sinewave
TCXO / VCTCXO	TCXO	TCXO	VCTCXO	VCTCXO	TCXO	TCXO	VCTCXO	VCTCXO
Supply Voltage	3.3Vdc	3.3Vdc	3.3Vdc	3.3Vdc	5.0Vdc	5.0Vdc	5.0Vdc	5.0Vdc
Frequency Range	6 to 40 MHz	6.4 to 52 MHz	6 to 40 MHz	6.4 to 52 MHz	6 to 40 MHz	6.4 to 52 MHz	6 to 40 MHz	6.4 to 52 MHz
Frequency Stability	±0.50ppm (Note 1)							
Temperature Range	0 to 70°C							

Table 3.0

Model Number	TA6E	TB6E	TE6E	TF6E	TC6E	TD6E	TG6E	TH6E
Output Type	LVC MOS	Clipped Sinewave	LVC MOS	Clipped Sinewave	HCMOS	Clipped Sinewave	HCMOS	Clipped Sinewave
TCXO / VCTCXO	TCXO	TCXO	VCTCXO	VCTCXO	TCXO	TCXO	VCTCXO	VCTCXO
Supply Voltage	3.3Vdc	3.3Vdc	3.3Vdc	3.3Vdc	5.0Vdc	5.0Vdc	5.0Vdc	5.0Vdc
Frequency Range	6 to 40 MHz	6.4 to 52 MHz	6 to 40 MHz	6.4 to 52 MHz	6 to 40 MHz	6.4 to 52 MHz	6 to 40 MHz	6.4 to 52 MHz
Frequency Stability	±0.50ppm (Note 1)							
Temperature Range	-40 to 85°C							

Table 4.0

±1.00ppm Model Specifications

Model Number	TA5F	TB5F	TE5F	TF5F	TC5F	TD5F	TG5F	TH5F
Output Type	LVC MOS	Clipped Sinewave	LVC MOS	Clipped Sinewave	HCMOS	Clipped Sinewave	HCMOS	Clipped Sinewave
TCXO / VCTCXO	TCXO	TCXO	VCTCXO	VCTCXO	TCXO	TCXO	VCTCXO	VCTCXO
Supply Voltage	3.3Vdc	3.3Vdc	3.3Vdc	3.3Vdc	5.0Vdc	5.0Vdc	5.0Vdc	5.0Vdc
Frequency Range	6.4 to 52 MHz							
Frequency Stability	±1.00ppm (Note 1)							
Temperature Range	0 to 70°C							

Table 5.0

Model Number	TA6F	TB6F	TE6F	TF6F	TC6F	TD6F	TG6F	TH6F
Output Type	LVC MOS	Clipped Sinewave	LVC MOS	Clipped Sinewave	HCMOS	Clipped Sinewave	HCMOS	Clipped Sinewave
TCXO / VCTCXO	TCXO	TCXO	VCTCXO	VCTCXO	TCXO	TCXO	VCTCXO	VCTCXO
Supply Voltage	3.3Vdc	3.3Vdc	3.3Vdc	3.3Vdc	5.0Vdc	5.0Vdc	5.0Vdc	5.0Vdc
Frequency Range	6.4 to 52 MHz							
Frequency Stability	±1.00ppm (Note 1)							
Temperature Range	-40 to 85°C							

Table 6.0

Note: 1) Frequency stability vs. change in temperature. $[\pm(F_{max} - F_{min})/2 \cdot F_0]$.

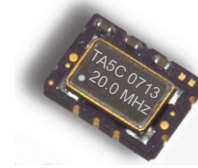

Features

- TCXO or VCTCXO
- 3.3V or 5.0V Operation
- CMOS Output or Clipped Sinewave Output
- Frequency Stability:
 - Tx5C/Tx6C - Series ±0.25ppm
 - Tx5E/Tx6E - Series ±0.50ppm
 - Tx5F/Tx6F - Series ±1.00ppm
- Temperature Range:
 - Tx5x-Series 0 to 70°C
 - Tx6xx-Series -40 to 85°C
- Low Jitter <1pS RMS
- Tri-State Enable/Disable
- Surface Mount Package
- Tape and Reel Packing
- RoHS Compliant / Lead Free

CMOS Test Circuit

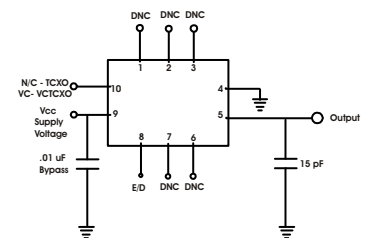

Clipped Sinewave Test Circuit

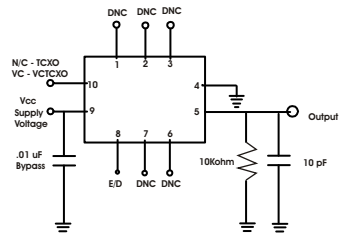

US Headquarters:
630-851-4722
European Headquarters:
+353-61-472221

Bulletin	Tx180
Page	2 of 4
Revision	04
Date	10 Aug 2007

Electrical Specifications for all Models

ABSOLUTE MAXIMUM RATINGS

TABLE 7.0

PARAMETER	UNITS	MINIMUM	NOMINAL	MAXIMUM	UNITS	NOTE
Storage Temperature		-55	-	125	°C	
Supply Voltage	(Vcc)	-0.5	-	6.0	Vdc	
Input Voltage		-0.5	-	Vcc+0.6	Vdc	

OPERATING SPECIFICATIONS

Table 8.0

PARAMETER	MINIMUM	NOMINAL	MAXIMUM	UNITS	Notes	
TCXO Frequency Calibration @ 25°C	-1.00	-	1.00	ppm	1	
Aging First Year	≤ 20 MHz	-1.00	-	1.00	ppm	
	> 20 MHz	-2.00	-	2.00	ppm	
Total Aging for 10 years		-5.00	-	5.00	ppm	
Supply Voltage Variation. (Vcc±5%)		-0.2	-	0.2	ppm	
Load Coefficient, ±5pF		-0.2	-	0.2	ppm	
Frequency shift after reflow soldering		-1.00	-	1.00	ppm	
Supply Voltage	(Vcc)	3.135	3.3	3.465	Vdc	2
	(Vcc)	4.75	5.0	5.25	Vdc	2
Supply Current	(Icc)	-	6	10	mA	
Jitter (BW=10Hz to 20MHz)		-	-	5	ps rms	
Jitter (BW=12kHz to 20MHz)		-	-	1	ps rms	
SSB Phase Noise at 10Hz offset		-	-80	-70	dBc/Hz	
SSB Phase Noise at 100Hz offset		-	-110	-100	dBc/Hz	
SSB Phase Noise at 1KHz offset		-	-135	-130	dBc/Hz	
SSB Phase Noise at >10KHz offset		-	-150	-145	dBc/Hz	
SSB Phase Noise at >100KHz offset		-	-150	-150	dBc/Hz	
Startup Time		-	-	10	ms	

INPUT CHARACTERISTICS for ENABLE / DISABLE FUNCTION (Pin 8)

Table 9.0

PARAMETER	MINIMUM	NOMINAL	MAXIMUM	UNITS	Notes	
Enable Voltage (High) or open circuit	(Vih)	70% Vdd	-	-	Vdc	3
Disable Voltage (Low) Output Tri-stated	(Vil)	-	-	30% Vdd	Vdc	

INPUT CHARACTERISTICS for VOLTAGE CONTROL (Pin10)

Table 10.0

PARAMETER	MINIMUM	NOMINAL	MAXIMUM	UNITS	Notes	
Control Voltage Range	(Vcc = 3.3V) (Vc)	0.30	1.65	3.00	Vdc	
	(Vcc = 5.0V) (Vc)	0.50	2.50	4.50	Vdc	
Frequency Tuning		±10	-	-	ppm	4
Linearity		±5	-	-	%	
Slope		Positive	-	-		
Input Impedance		100K	-	-	Ohms	

CMOS OUTPUT CHARACTERISTICS

Table 11.0

PARAMETER	MINIMUM	NOMINAL	MAXIMUM	UNITS	Notes	
LOAD	-	-	15	pF		
Voltage (High)	(Voh)	90%Vcc	-	-	Vdc	
(Low)	(Vol)	-	10%Vcc	-	Vdc	
Current (High)	(Ioh)	-4	-	-	mA	
(Low)	(Iol)	-	4	-	mA	
Duty Cycle at 50% of Vcc		45	50	55	%	
Rise / Fall Time 10% to 90%		-	-	8	ns	

CLIPPED SINEWAVE OUTPUT CHARACTERISTICS

Table 12.0

PARAMETER	MINIMUM	NOMINAL	MAXIMUM	UNITS	Notes
Load	-	10KOhm/10pF	-	-	5
Output Voltage (≤ 30 MHz)		1.00	-	-	V pk-pk
Output Voltage (> 30 MHz)		0.80	-	-	V pk-pk

Notes:

- 1) TCXO: Initial calibration @ 25°C. Specifications at time of shipment after 48 hours of operation.
- 2) For best in application performance, careful selection of an external power source is critical. Select an external regulator that meets or exceeds the following specifications regarding voltage regulation tolerance, initial accuracy, temperature coefficient, voltage noise, and low voltage noise density.
Factory Test Conditions: Initial Accuracy ±2mv, Noise (0.1Hz to 10 KHz) 15uV p-p, Voltage Noise Density = 50nV/sqrt Hz, Temperature Coefficient < 5ppm/°C.
- 3) Leave Pad 8 unconnected if enable / disable function is not required. When tri-stated, the output stage is disabled but the oscillator and compensation circuit are still active (current consumption ≤ 1 mA).
- 4) Additional pull ranges are available; please contact the factory for additional information.
- 5) Output is AC coupled.

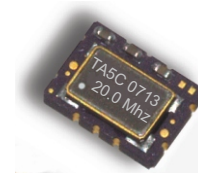

Features

TCXO or VCTCXO
 3.3V or 5.0V Operation
 CMOS Output or
 Clipped Sinewave Output
 Frequency Stability:
 Tx5C/Tx6C - Series ±0.25ppm
 Tx5E/Tx6E - Series ±0.50ppm
 Tx5F/Tx6F - Series ±1.00ppm
 Temperature Range:
 Tx5x-Series 0 to 70°C
 Tx6xx-Series -40 to 85°C
 Low Jitter < 1ps RMS
 Tri-State Enable/Disable
 Surface Mount Package
 Tape and Reel Packing
 RoHS Compliant / Lead Free

CMOS Test Circuit

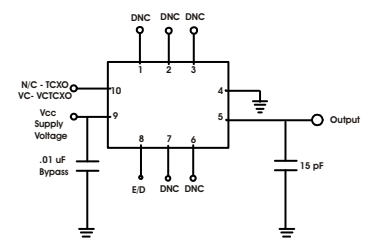

Clipped Sinewave Test Circuit

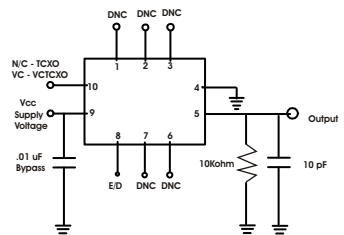

US Headquarters:

630-851-4722

European Headquarters:

+353-61-472221

Bulletin Tx180

Page 3 of 4

Revision 04

Date 10 Aug 2007

Design Recommendations

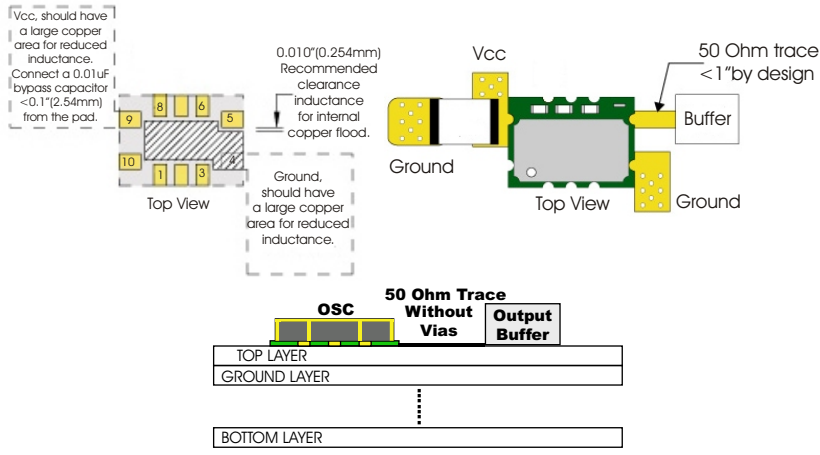

Package Characteristics

Package	Ceramic Surface Mount Package.
---------	--------------------------------

Environmental Characteristics

	Table 14.0
Vibration:	Vibration per Mil Std 883E Method 2007.3 Test Condition A
Shock:	Mechanical Shock per Mil Std 883E Method 2002.4 Test Condition B.
Soldering:	SMD product suitable for Convection Reflow soldering. Peak temperature 260°C. Maximum time above 220°C, 60 seconds.
Solderability:	Solderability per Mil Std 883E Method 2003

Suggested Pad Layout

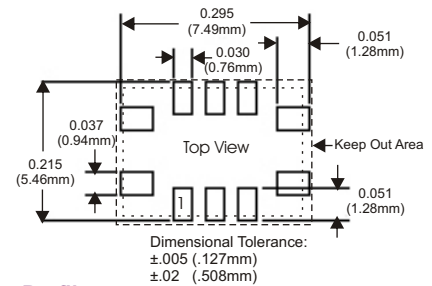

Typical Phase Noise

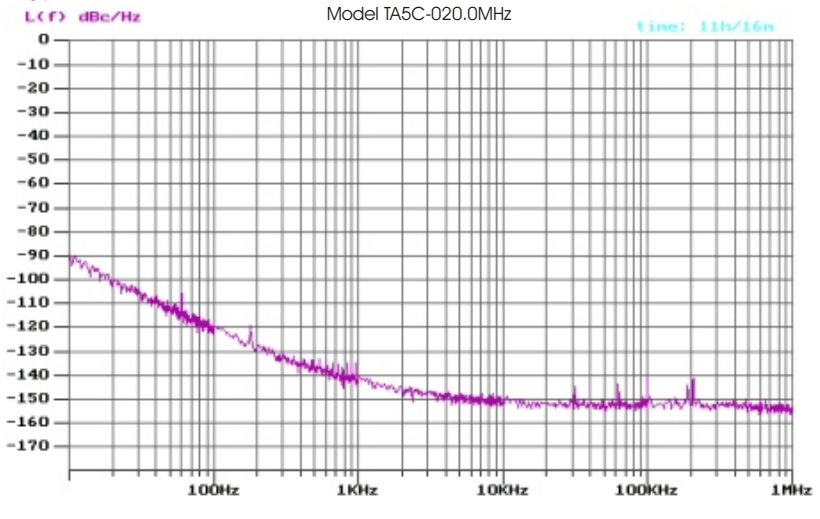

Solder Profile

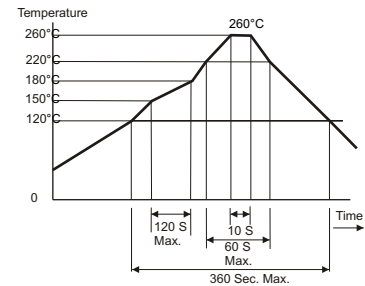

LVC MOS Output Waveform

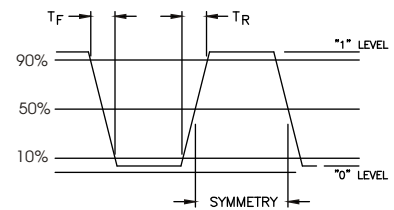

Clipped Sinewave Output Waveform

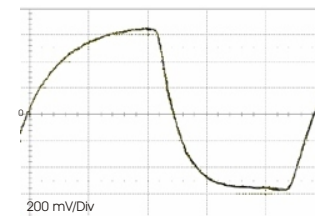

Tape and Reel Specifications

MEETS EIA-481A AND EIAJ-1009B
2000 PCS/REEL MAXIMUM

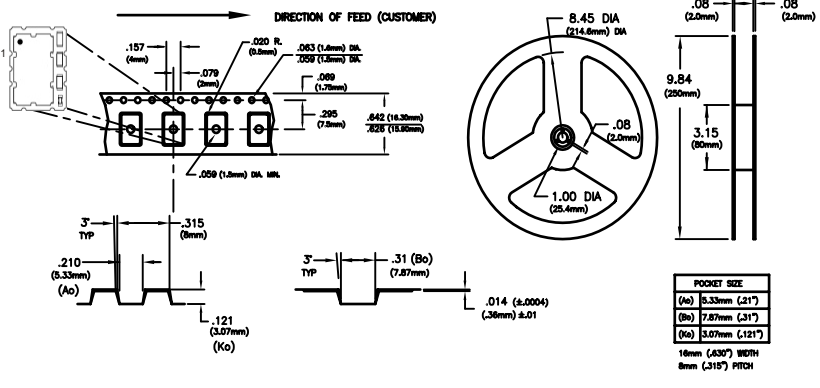

US Headquarters:

630-851-4722

European Headquarters:

+353-61-472221

Bulletin Tx180

Page 4 of 4

Revision 04

Date 10 Aug 2007